

## White Paper

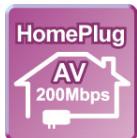

### HomePlug AV 200Mbps Ethernet Bridge Series BiPAC 2073 R2/BiPAC 2074 R2

- Extend Your Home Networking through Power Lines



## Table of Contents

1. Overview – Power Line Communication (PLC)
2. Introduction of HomePlug AV
3. What's Unique about Billion's PLC
  - 3.1. Power Saving feature
  - 3.2. Extra Power Outlet with Noise Filter - AC Pass-Through Power Socket
4. Application of HomePlug AV
5. Summary



## 1. Overview – Power Line Communication (PLC)

In recent years, Power Line Communication has emerged as a new generation of networking and it has become increasingly popular among residential and small sized office settings. The use of twisted pair cable or optic fiber as transmission media in Ethernet not only costs a fortune in setting up a complicated cabling system, it may also cause some renovation issue. In addition, the use of wireless networking in data transmission has certain restrictions that may reduce the quality of multimedia content.

Power line networking however uses the existing electrical wiring system of a home or an office to transfer digital data. This technology can therefore solve the problems mentioned earlier. With the improving technology of power line networking, apart from transmitting the traditional data signal, we have expanded its capacity to deliver high quality digital multimedia content, such as music and video.

The manufacturer will either provide 3C products that support PLC power line networking or through high-speed transmission and multimedia communication protocol to integrate Wireless/HomePNA/DLNA.

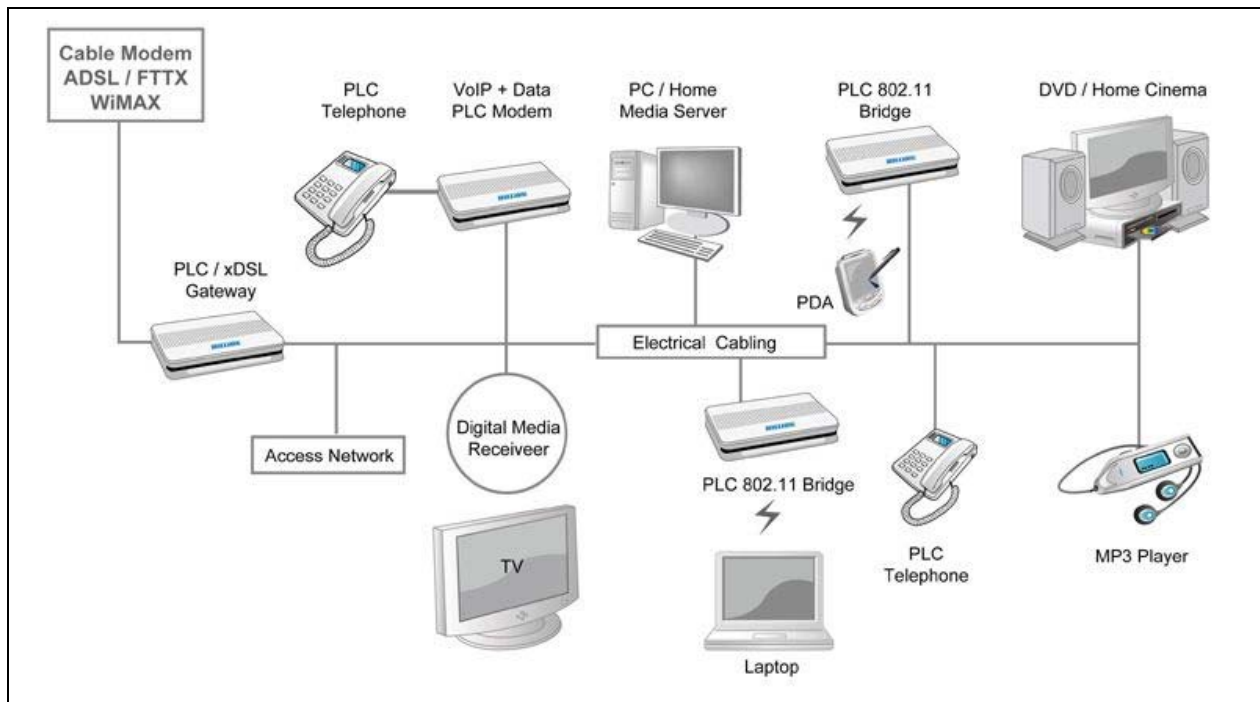



## 2. Introduction of HomePlug AV

HomePlug Powerline Alliance is the power line networking alliance and it is also the organization that sets the HomePlug standard. There are currently 50 members in this organization comprised mainly of networking and information technology professionals from some of the renowned companies like Cisco/Linksys, GE, LG, Motorola, Samsung, Sharp, TI, Intel and Conexant.

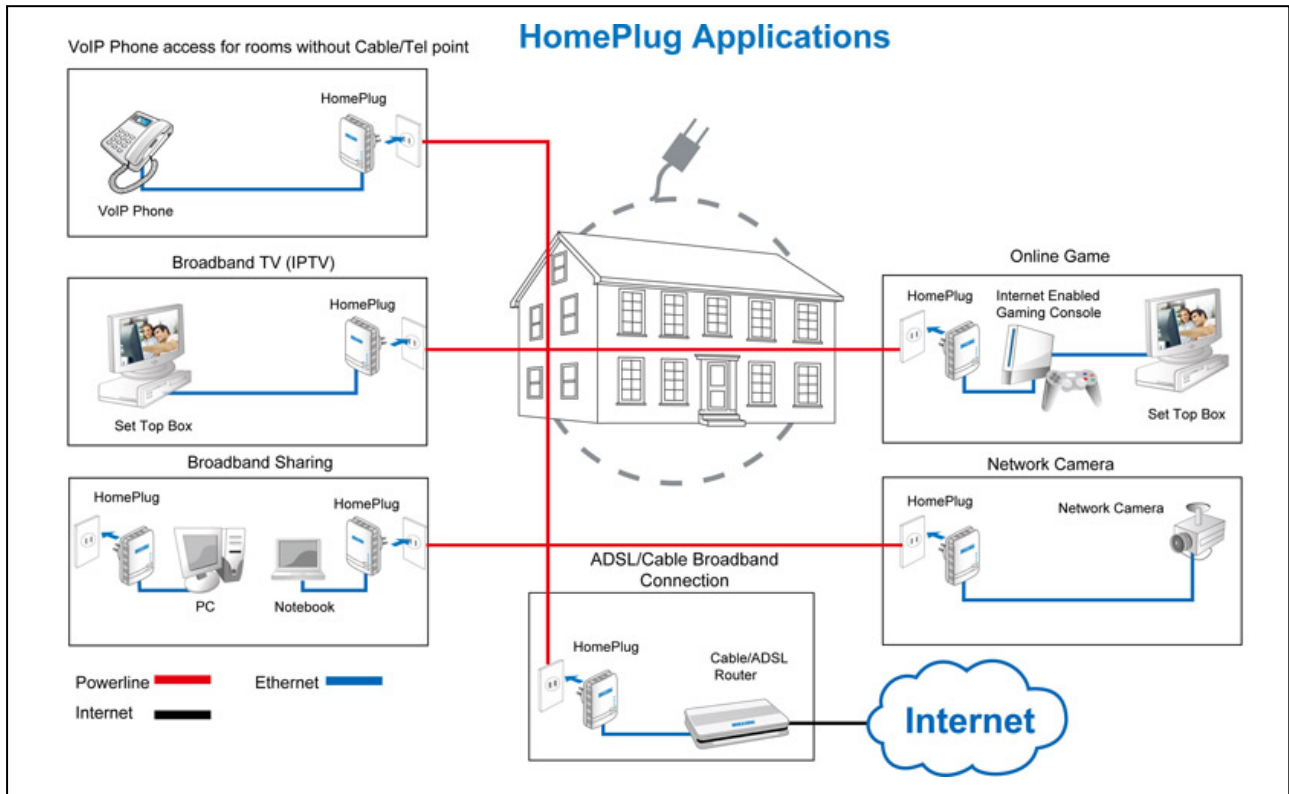

First generation of the HomePlug 1.0 device can only support a maximum transmission rate up to 14Mbps, but its successor HomePlug AV has been upgraded to handle a high-speed transmission rate of 200Mbps, which is much greater than 100Mbps. Moreover, the use of the traditional Ethernet networking can cause all the Ethernet cables laid around to congest all the space in your house or office, if there are a lot of computers present.

Thus, HomePlug AV has become a great advantage by utilizing the already present electrical wiring system as a path to transfer digital data. It is because there are already a lot of power outlets present in a house and many of the power outlets are located in areas where your home entertainment center or networking system are located as well. This can certainly make your networking setup and connection a lot more convenient and efficient.



Below is the table that shows the specification differences between HomePlug 1.0 and HomePlug AV.

	HomePlug 1.0 (INT5200)	HomePlug 1.0 w/Turbo (INT5500)	HomePlug AV (INT6xxx)
<b>PHY Rate</b>	14Mbps	85Mbps	200Mbps
<b>Peak Throughput</b>	8Mbps	35Mbps	105Mbps
<b>Typical Power Line Throughput</b>	4-6Mbps	8-12Mbps	40-45Mbps
<b>Typical Coax Throughput</b>	7-8Mbps	28-32Mbps	80-90Mbps
<b>Bandwidth</b>	4-21MHz	4-21MHz	2-30MHz
<b>Host Interfaces</b>	MII, USB, Ethernet	MII, Ethernet	MII, Ethernet, PCI
<b>Channel Access (QoS)</b>	CSMA/CA (4)	CSMA/CA (4)	CSMA/CA (8)
<b>Max Modulation</b>	DQPSK	256-QAM	1024-QAM

Currently, there are three major manufacturers whose Powerline chip solutions are popular on the market - DS2, Panasonic and HomePlug AV. Although each of these manufacturers has its own popularity, the chip solution of Intellon provides a noise filter feature that enhances the quality and stability of multimedia streaming for IPTV, making the Intellon chip solution better than the other two manufacturers.

The table below presents the pros and cons of the Powerline devices of each manufacturer.

	HomePlug AV	Panasonic	DS2
<b>Medium</b>	Powerline, Coax, Twisted pair	Powerline	Powerline
<b>PHY Rate</b>	200Mbps	190Mbps	200Mbps
<b>Ubiquity</b>	Whole-house	Noise-limited	Noise-limited
<b>Stream HD</b>	Multi-stream	Not reliable, Noise-impaired	Not reliable, Noise-impaired
<b>Ease of Use</b>	No software needed. Plug-n-play Pushbutton	Plug-n-play Pushbutton	Plug-n-play Pushbutton
<b>Open Standard</b>	Global HomePlug Powerline Alliance	Proprietary (CEPCA)	Proprietary (OPERA, UPA)
<b>Noise Immunity</b>	Good	Poor	Poor
<b>Access Protocols</b>	CSMA/CA, Parameterized QoS	CSMA/CA TDMA	TDMA



Billion BiPAC 2073 R2/2074 R2 uses the Intellon INT6400 HomePlug AV solution that bridges Powerline networking and Ethernet networking. It also incorporates the Orthogonal Frequency Division Multiplexing (OFDM) modulation technique and a noise filter feature that provides an excellent transmission rate as well as high quality and stable transmission.

## BiPAC 2073 R2/2074 R2 product specifications and features:

- **Network standard** : HomePlug AV , 200Mbps transmission rate
- **Modulation technique** : OFDM , support QAM 1024/256/64/16, DQPSK, DBPSK and ROBO
- **Bandwidth** : 2MHz ~ 30MHz
- **Network range** : up to 300m
- **Encryption** : 128bit AES encryption
- **Smart Power Saving** : Auto detect ETH signal, save up to 20% power reduction in full operation and up to 50% power reduction in standby mode
- **QoS** : Auto modulate the transmission priority , Multicast and MOD are set to have the highest priority by default, will not affect IPTV and VoIP transmission
- **Hardware Specification** : Auto MDI/MDIX with 10/100Mbps Ethernet port  
A built-in power outlet : 100-240VAC , 50/60Hz (BiPAC2074 R2 has an AC outlet)
- **LED** : Power LED, PLC LED, Ethernet LED, HomePlug 1.0 Detect LED (when this LED is lit, HomePlug AV has detected the presence of HomePlug 1.0 device in the network environment, but communication cannot be established between the two).
- **Button feature** : Sync button & Reset button
- **Power safety Mark** : CE, FCC



## 3. What's Unique about Billion's PLC

### 3.1. Smart Power Saving feature

When the PC is off or during its standby mode, Billion PLC will automatically switch from its regular "working" power mode to power saving mode. With this feature, Billion PLC can help save up to 60% of power consumption - this feature also applies under 264V circumstance.

AC Power	Power consumption (Working mode)	Power consumption (Power saving mode)	Power saving percentage
AC 90V/60HZ	3.4W	0.45W	87%
AC 110V/60HZ	3.49W	0.57W	84%
AC 230V/50HZ	4.66W	1.57W	66%
AC 264V/50HZ	5.18W	1.99W	62%

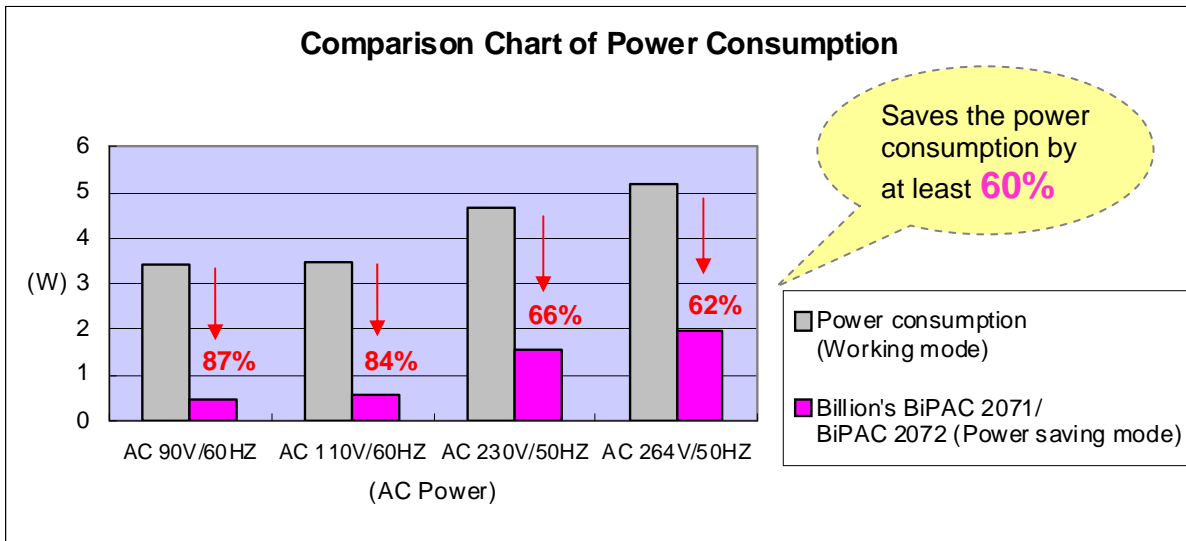



### 3.2. Extra Power Outlet with Noise Filter - AC Pass-Through Power Socket

BiPAC 2074 R2 comes with a built-in AC Pass-Through Power Socket and noise filter feature. The AC Pass-Through Power Socket is an extra set of power outlet that can be used by other electrical appliances such as table lamp, hair dryer or power charger. However, some of these electrical appliances may generate some noise that may cause interference during data transfer. Therefore, the noise filter will eliminate the interference generated and enhance the quality of data transfer.

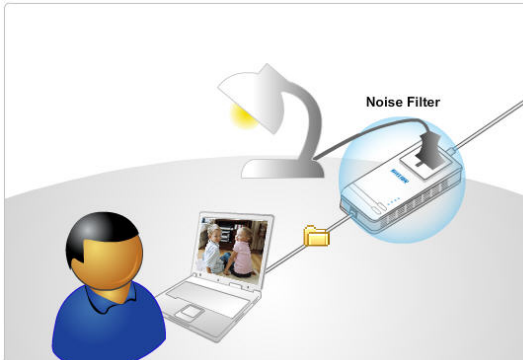
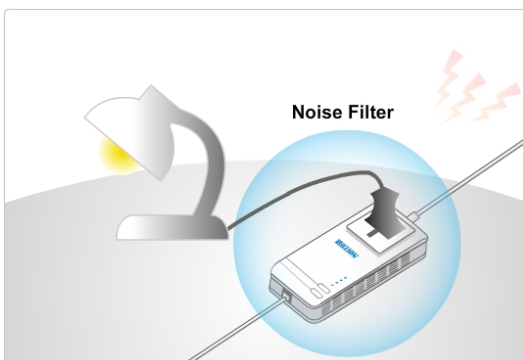
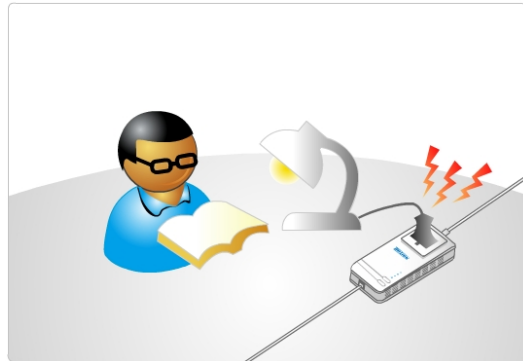

※ Four scenarios below were developed in an 87 square-meter apartment with different types of electrical appliances in use to evaluate the effectiveness of BiPAC 2074 R2.

- **Baseline test** – used the AC Pass-Through Power Socket to evaluate communications coverage in the house, but did not use its built-in AC Pass-Through Power Socket or any other filtering.
- **Pass-through only** – used BiPAC 2074 R2 AC Pass-Through Power Socket and the built-in power outlet to isolate the appliances associated with the outlet under test without using the noise filter feature.
- **Filter on severe noise sources** – same as Pass-through only, but now the halogen lamp and both phone chargers were isolated from the power line network using the Noise Filter feature.
- **Filter on both severe and moderate noise sources** – same as filter on noise sources above, but with the addition of the moderate noise sources as listed in Table 2.



**Table 1:** listing of all the appliances used and their respective locations

**Table 2:** noise tests categorized as - Severe/Moderate/Minor

**Table 1: Equipment List for the Apartment (APT1)**

Communication Site	Equipment list	Location (room)
1	Jensen TV Polaroid DVD player Generic PC HP printer Fluorescent lamp	Living room
2	NA	Dinning room
3	AFCI breaker in power panel	Kitchen
4	NA	Master bedroom

**Table 2: Noise Sources in the Apartment (APT1)**

Description	Type	Location (room)
AC cell phone charger	<b>Severe</b> / Moderate / Minor	Kitchen
Fluorescent lamp	Severe / <b>Moderate</b> / Minor	Living room by PC
Fluorescent lamp	Severe / <b>Moderate</b> / Minor	Living room
Fluorescent lamp	Severe / <b>Moderate</b> / Minor	Master bedroom

The actual tests have shown that under the Pass-through only situation, noise resistant capability is 18% higher than the Baseline test. Overall, there is an approximated 24% improvement when all appliances are being evaluated together under an actual circumstance.

※ Data obtained from Intellon's self evaluation. Test results will change in accordance to each test scenario.



## 4. Application of HomePlug AV

The application of home digital multimedia has become increasingly wider, such as IPTV, VOD, VoIP and online games. More and more consumers now watch movies, music or sports channels through an interactive network platform. With the high transfer rate of 200Mbps and the HomePlug AV technology, Billion BiPAC 2073 R2/2074 R2 can be easily integrated into a normal home setting.

BiPAC 2073 R2/2074 R2 also includes a Quality of Service (QoS) feature that guarantees the transmission quality by automatically prioritizing data that ensures optimal transmission quality for streaming applications such as IPTV, MOD, VoIP and Multicast that demand a stable bandwidth stream. The device provides an efficient noise filtering feature during data transmission. Thus, you will not experience any interruption or image freezes during real-time data streaming, particularly when you share multimedia content or video with others in a different room.

Generally, television and other household appliances are in different rooms or places within the house (as illustrated below). BiPAC 2073 R2/2074 R2 does not require the time and money needed to install Ethernet cables throughout your house. The device supports high-speed transmission rates for IPTV and MOD services via the existing power line network - just install the bridge utility, which is simple and easy and without extra configuration. If there are two or more BiPAC 2073 R2/2074 R2 devices, connect one of the devices to Billion ADSL router, so the other device(s) is allowed to transfer data (both audio and video) to Billion ADSL router via the electrical wiring and then access ISP's network programs or Internet through your Internet connection.

It makes home network multimedia applications become easy and exciting!

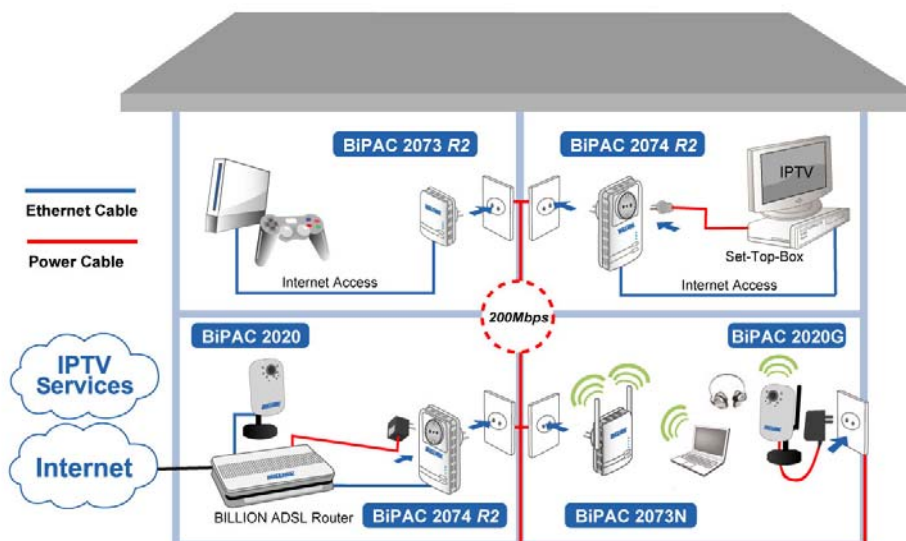



## 5. Summary

The HomePlug AV standard provides data transfer rate of up to 200Mbps. Most of the multi-media applications are transferred through the Internet in the house. BiPAC 2073 R2/2074 R2 uses HomePlug AV to establish super fast network connectivity. Additionally, it does not require the time and money needed to install any other device, nor does it require any drilling in the house, thus it helps to avoid problems that might have arisen from signal instability over wireless networks.

HomePlug AV enables users in the same power loop to bridge modems, routers, PCs, set-top-boxes, and game consoles and easily setup a data network accessible through existing in-home power lines and share bandwidth-consuming applications with family all around the house.

BiPAC 2073 R2/2074 R2 with smart power saving feature can automatically detect its Ethernet connection. When an Ethernet-based device is powered down or disconnected, the BiPAC 2073 R2/2074 R2 adapter will automatically fall into sleep mode, which reduces power consumption significantly. Furthermore, when the current usage is in full operation, the adapter can reduce its power consumption which in turn saves money on your electricity bill.

In addition, BiPAC 2074 R2 (HomePlug AV 200 Ethernet Bridge with AC Pass-Through Power Socket) features a built-in electrical power outlet with noise filter- AC Pass-Through Power Socket. This handy add-on offers users an additional power extension for other electrical devices where limited wall outlets exist. With noise filtering, the BiPAC 2074 R2 enhances power-line communications coverage and supports superior and noise-immune data transmission.

Billion's HomePlug AV 200Mbps series combine these specific features to enable users to access the Internet applications through the power lines.

### **HomePlug AV 200Mbps - BiPAC 2073 R2/2074 R2**

#### **White Paper**

Copyright © Billion Electric Co., Ltd.

**Technical Support** : support@billion.com

[www.billion.com](http://www.billion.com)